

52 Bottle Wine Rack Stackable

Instruction Sheet

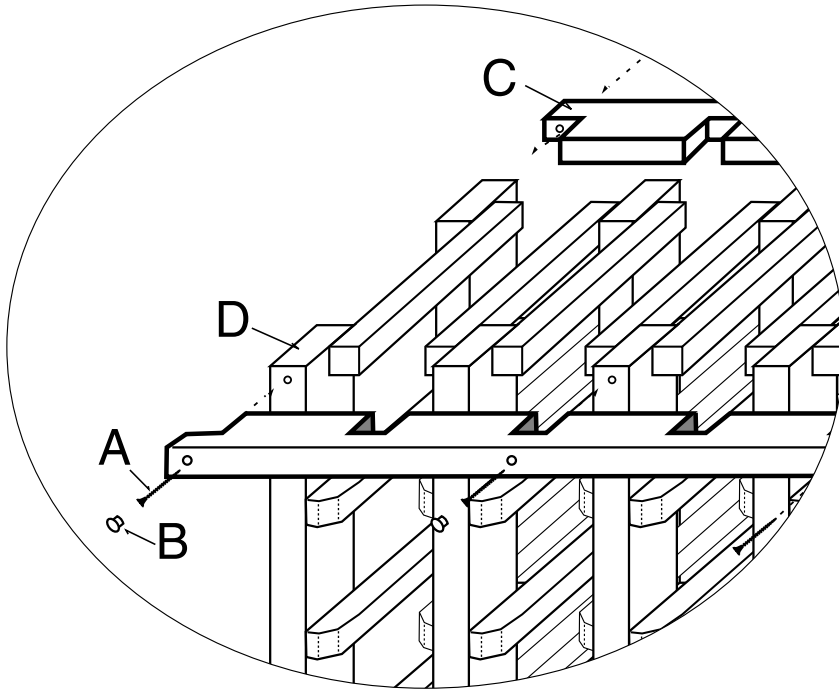

ASSEMBLY INSTRUCTIONS:

- All screw holes should have a 1/16" pilot hole pre-drilled before inserting screws
- Install Screws (A) into rear of Frame Sections (C) and Bottle Supports (D)
(be sure beveled edges face towards front of rack)
- Carefully invert partially assembled rack so that frame sections are on the ground.
- Install remaining bottle supports into rear of frame
- Install front frame sections and remaining screws
- Install screw hole plugs (B) on front of rack only

Manufactured by:

**Wine
Cellar
Creations**

Wine Racking System
Custom Wine Cellars,
Cooling Units &
Accessories

905-666-0200

50 Winter Crt., Whitby, Ontario L1N 8Y1

